

**Flexibility & Modularity**  
Customizable. Scalable. Adaptable.

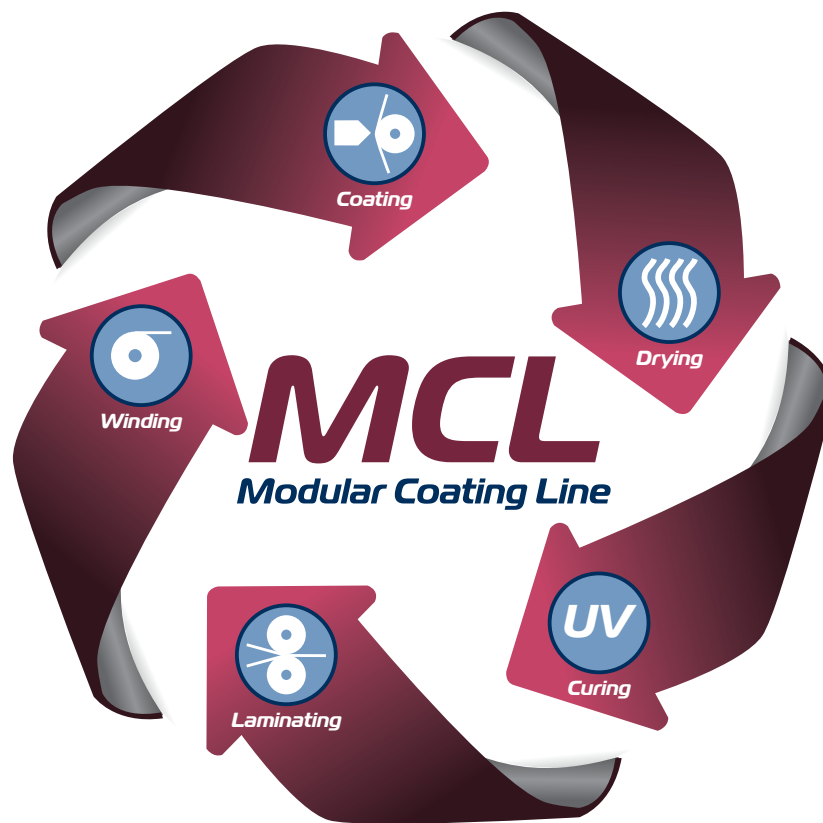

Production-Level Modular Coating Line

**MCL300**  
Modular Coating Line

**MCL600**  
Modular Coating Line

## BASE CONFIGURATION

- Primary Unwind
- Coater Base
- Single-Zone Flotation Dryer
- Dry-Bond Laminator
- Laminate Unwind
- Rewind
- Control System
- Static Control
- Roll Handling Cart

## OPTIONAL CONFIGURATIONS

- Coating Modules
- Corona Treaters
- Customized Dryer Configurations
  - Idler Support
  - Multiple Dryer Zones
- E-Beam or UV Curing
- Lamination Options
- Turrets with Automatic Splicer & Transfer Units
- Coater Enclosures
- Clean Room

## COATING METHODS

- Comma Coater Module
- Roll Coater Module
  - Direct Gravure
    - Enclosed Applicator
    - Pan Fed
  - Offset Gravure
    - Enclosed Applicator
    - Pan Fed
  - Pressurized Gravure
  - Rod Coating w/Vacuum Roll
  - Smoothing Bar
  - Mayer Rod
- Reverse Roll Coater Module
- 5-Roll Coater Module
- Slot-Die Coater Module
  - Conventional
  - Hot Melt

## MCL

### Flexible Design Allows for Custom Configuration & Expansion

The Modular Coating Line (MCL) is available in 300mm and 600mm configurations and serves a variety of end-use applications. A wide range of coatings including solvent, aqueous, E-Beam and UV may be processed on the MCL with the available standard options offered.

The modular design utilizes pre-engineered components. A complete line, even with the amount of customization available, can be delivered quickly at a lower cost than an equivalent machine produced from completely customized drawings, without sacrificing quality.

Flexibility of the configuration makes the MCL highly adaptable to fit the needs of all markets.

The drive can be preselected for either low-speed or high-speed web processing.

Drives and controls are completely integrated, and installation costs are minimized by prewiring and piping to the greatest extent possible. Ductwork is provided to connect the heating and air-handling skids to the dryer in the predefined location.

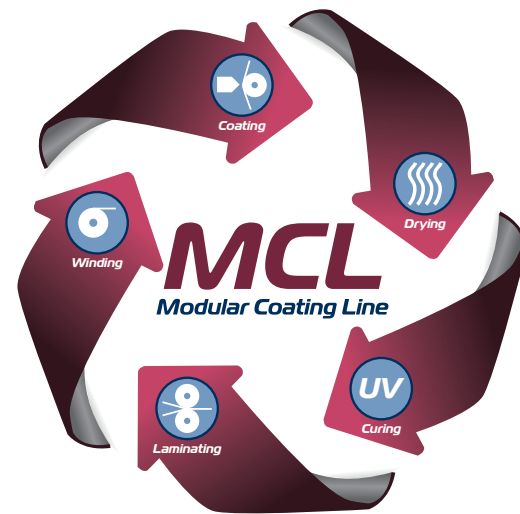

## Coating

### Interchangeable Coating Modules Offer Flexibility for All Markets

Coating modules are interchangeable so the MCL can be configured for a variety of coating methods that satisfy a broad range of applications. Coating modules can be added at any time as needs change. The MCL's modular construction with integral drive and control cabinets for each component makes future reconfiguration easier and reduces field installation time and expense.

A **Flex Spreader Roll** is included prior to the coater to reduce web-handling problems associated with baggy edges or centers of the web.

## Quick Change Coating Modules



### Choose a Module. Exchange a Module.

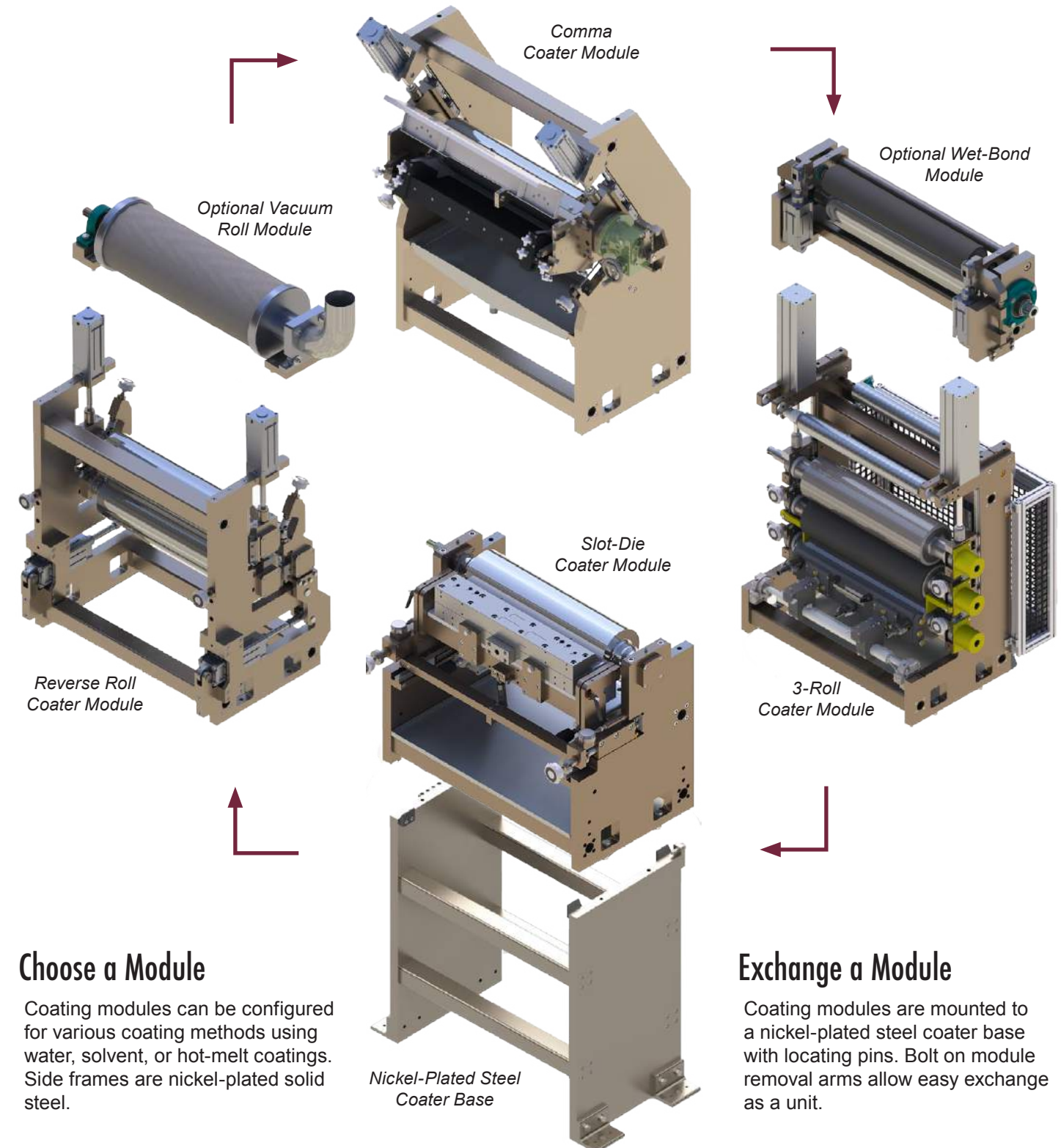

#### Choose a Module

Coating modules can be configured for various coating methods using water, solvent, or hot-melt coatings. Side frames are nickel-plated solid steel.

#### Exchange a Module

Coating modules are mounted to a nickel-plated steel coater base with locating pins. Bolt on module removal arms allow easy exchange as a unit.

## WINDING OPTIONS

- Web guide
- Foil handling package
- Plasma coated rollers for self-wound PSA
- Turret with automatic splicer and transfer units
- Dual fixed position spindles
- Lay-on roll for single roll rewind

## Winding



The MCL includes one rewind and two unwinds: primary and laminate.

A **Cantilevered Single Roll** can be unwound/wound in either direction. Closed-loop control with tension readout ensures regulated, constant winding tension. Roller bearings are located along the shaft and the adapter to facilitate roll removal. Winders include a regenerative drive, cantilevered air shaft, and full-length adapter.

The **Roll Cart** supports 610 mm (24") diameter rolls up to 227 Kg (500 lbs.) with 635 mm (25") maximum core lengths.

**Static Elimination** is effected by two single-sided, non-contact ionizing devices located at the primary unwind and rewind.

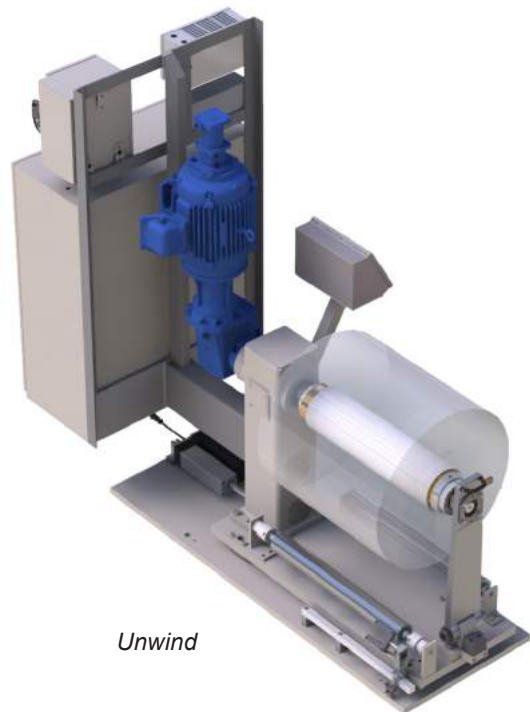

Unwind

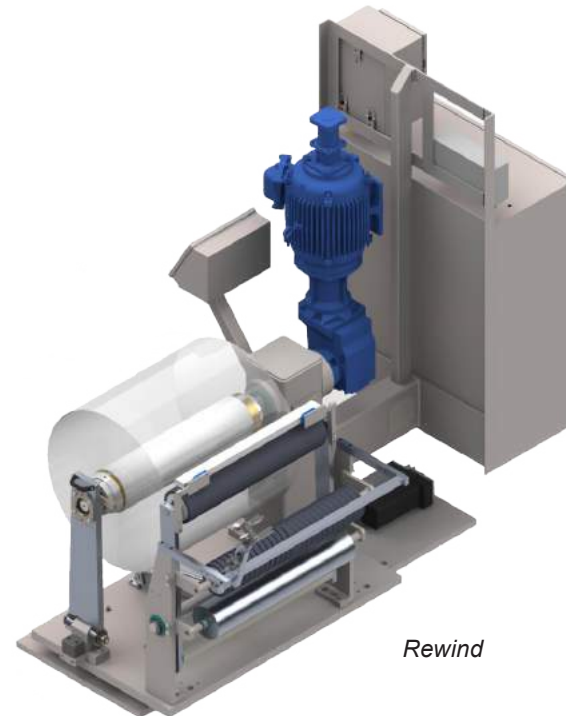

Rewind

## Laminating & Chilling



The **Dry-Bond Laminator** includes a double wall chrome plated laminating roll which can be heated, and dual post lamination chill rolls. The nip with adjustable stops can achieve a maximum loading of 150 PLI (26 N/mm). A fully enclosed guard protects operators from moving parts, while removable panels allow access for maintenance.

**Flex Spreader Rolls** are provided for both incoming webs.

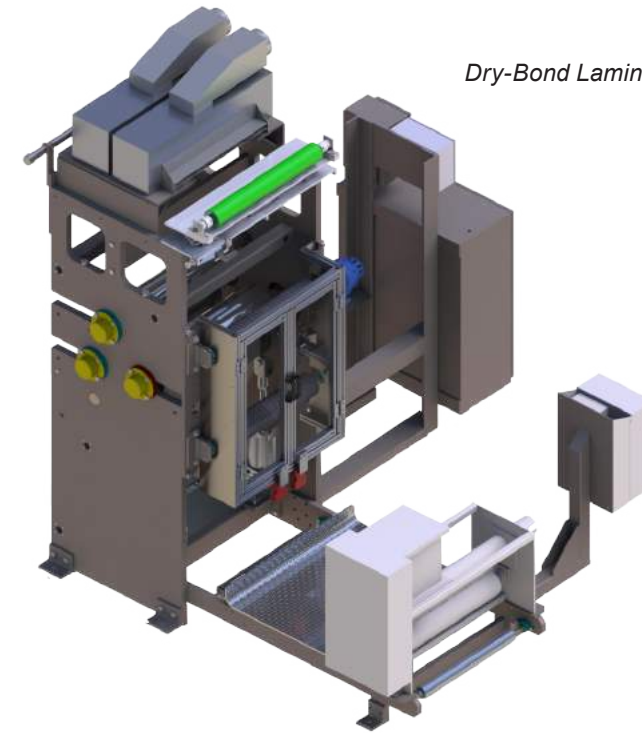

Dry-Bond Laminator

## LAMINATING OPTIONS

- Rotary Unions and Hoses
- Hot Water Unit
- Hot Oil Unit
- Chiller
- Wet Bond Laminator

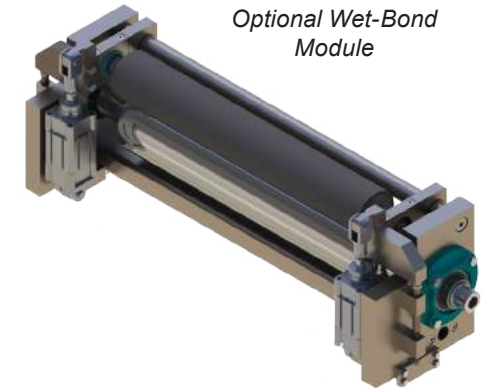

Optional Wet-Bond Module

Optional **Wet-Bond Laminator Module** easily attaches to 3-Roll Coater Module for quick-change laminating configurations.

## Drying/Curing



The **Single-Zone, High-Efficiency Gas Heated Flotation Dryer** has a double-wall enclosure. The dryer box is constructed of aluminized steel with internal headers, includes upper impingement nozzles, lower airfoils (for web stability) and freestanding air-handling units. The three-meter dryer section has access doors with double pane web observation windows to allow easy access for web-up and cleaning.

The **Dryer exit guide** includes electro mechanical actuator, ultrasonic sensing head and guide roll.

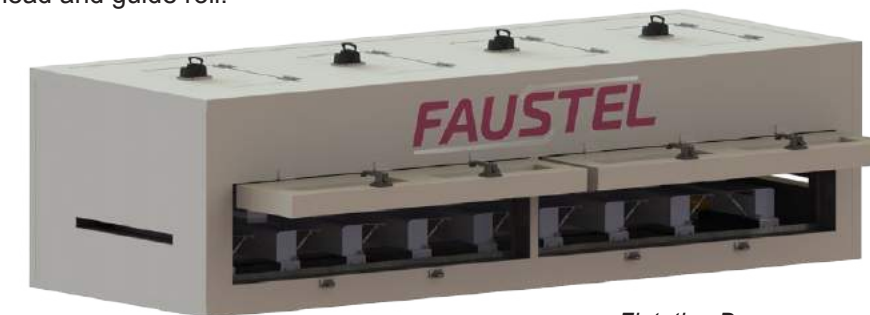

Flotation Dryer

## DRYING OPTIONS

- Additional Dryer Zones available in 3-meter sections.
- Electric Heat in lieu of gas burners.
- HEPA Filters
- Belt or Idler support
- Counter Flow
- Dryer Recirculation with manual lock down
- LEL Monitor for solvent-based coatings
- Stainless Steel Dryer Interior
- Cooling Zone with flotation top and bottom air
- UV Cure Unit configured for single or double-row non-inert operation or single row nitrogen inert operation
- E-Beam Curing

## CONTROL SYSTEMS

### OPERATOR CONTROLS

- 10" touch screen
- Local push-button stations or optional touch screen
- Main Control Panel optional
- Wonderware® CMS optional

### MACHINE CONTROL

- Advanced PLC System from Rockwell (A-B)

### DRIVE SYSTEMS

- In-house design and assembly
- AC Vector & optional AC Servo technology

## Control Systems



Control systems are designed and integrated by Faustel and include a Main Operator Console, Local Operator Stations, a Sectional Drive System and Programmable Logic Controller with open source code.

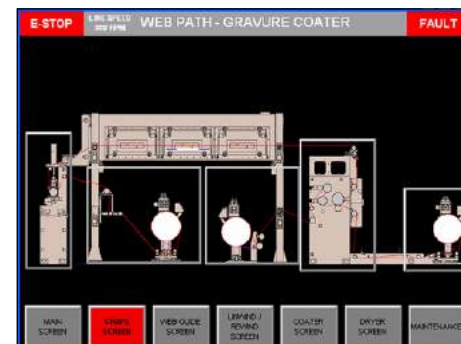

Operator Control Panel

# Example Machine Configurations

Customizable. Affordable. Reliable.

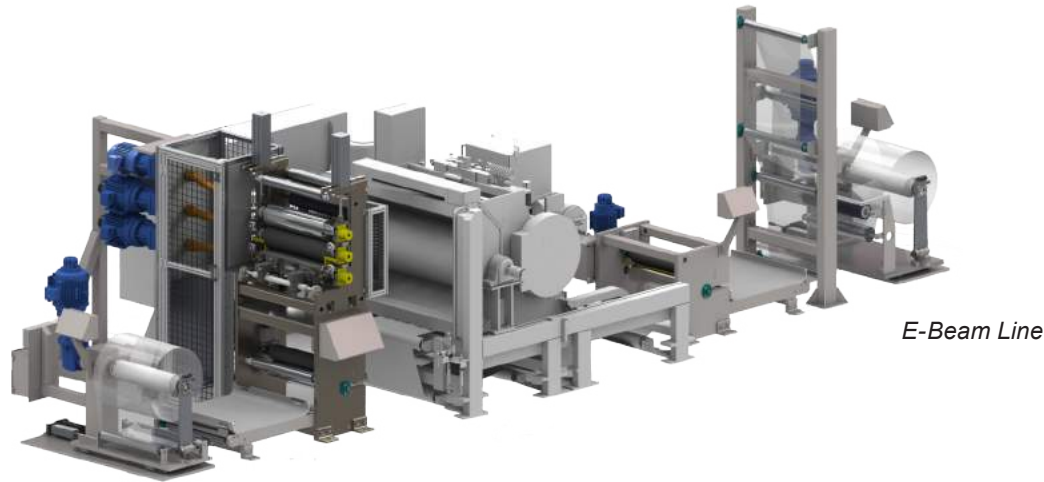

E-Beam Line

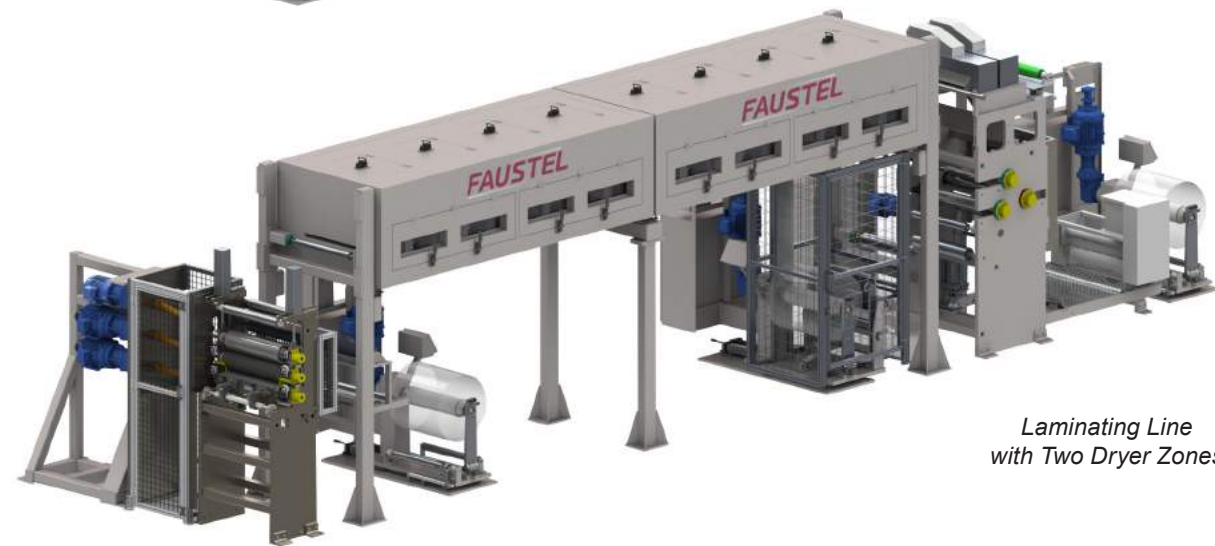

Laminating Line with Two Dryer Zones



Battery Coating Line with Six Dryer Zones

## SPECIFICATIONS

### 300 Web & Machine Widths

Max Web Width	356 mm	(14")
Max Coat Width	300 mm	(12")
Min. Web Width	76 mm	(3")
Min. Roll Face	380 mm	(15")

### 600 Web & Machine Widths

Max Web Width	635 mm	(25")
Max Coat Width	610 mm	(24")
Min. Web Width	152 mm	(6")
Min. Roll Face	660 mm	(26")

### Machine Speeds & Tensions

**Mechanical Speed Range:**  
1-20 m/min.  
(optional 5-100- m/min; 10-200 m/min.)

**Suggested Operating Range:**  
2-20 m/min.  
(optional 10-100 m/min; 20-200 m/min.)

**Line Tension Range**  
2-60 lbs. (9-267 N/m)  
0.25-2.5 PLI (44-438 N/m)

### Unwind/Rewind Specifications

Maximum Roll OD	610 mm	(24")
Maximum Roll Weight	227 Kg	(500 lbs.)
Roll Mounting	Shafted	
Core Length(s) Nominal	76-635 mm	(3"-25")
Core ID	76 mm (3")	152 mm (6")
Core OD	89 mm (3.5")	165 mm (6.5")
Core Material	Fiber or Plastic	

### Web Tension Examples

	Width	PLI	N/m
Paper	152 mm (6")	0.5-10.0	88-1,751
Film	300 mm (12")	0.25-5.0	44-876
Non-Woven	457 mm (18")	0.16-3.3	28-578
Foils	610 mm (24")	0.125-2.5	22-438

### MCL with Single-Zone

- l. 8.9 m (29')
- d. 5.0 m (16')
- h. 3.2 m (10')

### MCL with Two-Zones

- l. 12.5 m (41')
- d. 5.0 m (16')
- h. 3.2 m (10')

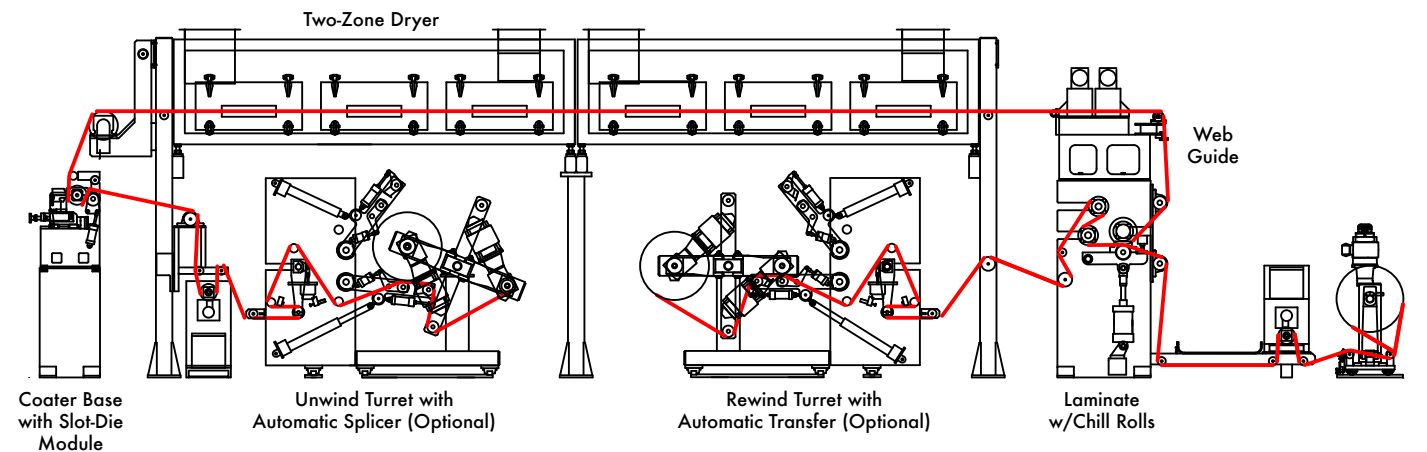
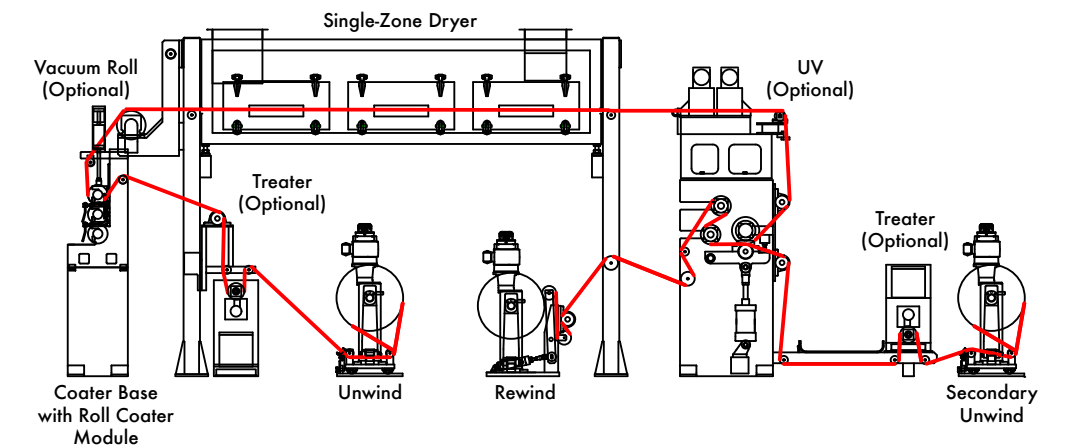

# FAUSTEL

## Engineered & Built To Meet Your Unique Specifications

### Leading-Edge Technology

- Unwinding & Winding
- Auto-Splacers & Core Transfers
- Coating  
(Fixed Frame or Cartridge)
- Laminating  
(Wet, Dry, or Thermal Bond)
- Drying  
(Roll Support, Belt, or Air Flotation)
- Curing  
(UV, E-Beam)
- Auxiliary Systems Integration  
(In-Line Coat Weight Measurement, Solvent Recovery & Distillation, Thermal Oxidizers, Closed Loop Coating Delivery, Corona Treatment, and Web Cleaners)
- Clean & Dry Room Configurations
- Drives & Controls
- Installation & Start Up

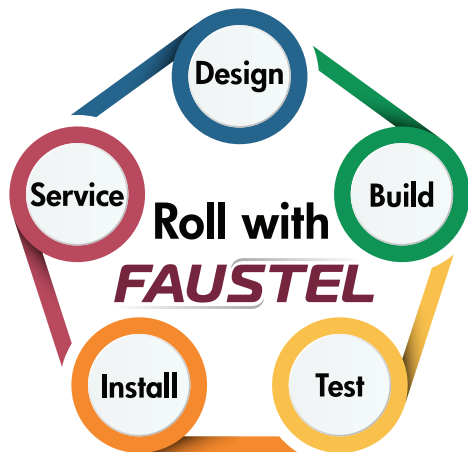

Coating • Laminating  
Winding • Drying • Controls

### Pre-Engineered Solutions

(TecMaster, LabMaster and MCL)

- System Options Configurable to your Process
- Rapid Delivery
- Economical to Install

### Specialized Solutions

- Battery and Battery Separators
- Reverse Osmosis Membranes
- Window Film
- Tape and Label
- Vinyl Casting
- Foil Lamination
- Medical Device & Pharmaceutical
- *Don't see your solution?*  
*Please call (262) 253-3333.*

### Custom Solutions

- Proven technology configured to your unique process requirements
- Stand-alone components and complete lines

## Process Development

Test • Adjust • Prove  
**QUALITY**  
We Help You Succeed

The In-House Technology Center is available for product development. It incorporates all well-known drying and curing technologies as well as a wide variety of coating, laminating, and winding capabilities.

## Parts & Service

(262) 253-3333  
**24-Hour**  
Technical Support Line

The 24-hour Technical Support Line is staffed with engineering specialists who have access to drawings, PLC programs, and vendor information to provide a quick response and minimize your downtime.

## Contact

W194 N11301 McCormick Dr.  
Germantown, WI 53022

(262) 253-3333  
www.faustel.com  
sales@faustel.com

Tongan Industrial Area  
Xiamen City, 361100 China  
86-592-7360378  
www.faustel.com.cn